



Agency Approvals

Agency	Standard	File Number
CE	EN 61643-11	LCS200109018AS

Electrical Data

Product model	ZP-LED-P10B(3L)	ZP-LED-P10B(5L)
SPD according to IEC/EN61643-11	Type2+Type3/Class II +ClassIII	Type2+Type3/Class II +ClassIII
Nominal operating voltage/ U_n	250V(50/60Hz)	250/500V(50/60Hz)
Max. continuous operating voltage/MCOV (U_c)	320V(50/60Hz)	550V(50/60Hz)
Nominal discharge current/ $I_n(8/20\mu s)$	5kA	5kA
Max. discharge current/ $I_{max}(8/20\mu s)$	10kA	10kA
Open-circuit voltage/ $U_{oc}(1.2/50\mu s \& 8/20\mu s)$	10kV	10kV
Voltage protection level/ $U_p(@I_n)$	$\leq 1200V$	$\leq 2000V$
Follow current extinguishing capability/ $I_n(N-PE)$	100A _{rms}	100A _{rms}
Temporary overvoltage TOV/ $U_T(L-N)$	337V/5sec.-withstand	337V/5sec.-withstand
Temporary overvoltage TOV/ $U_T(L-N)$	442V/120min.-safe failure	442V/120min.-safe failure
Operating state/fault indication(Optional)	on normally, off fault	on normally, off fault
Connecting wires	06 (RV) 1.0mm ²	06 (RV) 1.0mm ²
Protection mode	Single-phase	Three-phase
Enclosure material	Thermoplastic UL94-V0	Thermoplastic UL94-V0
Operating temperature range	-40°C~+85°C	-40°C~+85°C
Degree of protection	IP67	IP67
Product size	L74×W33×H32mm	L74×W33×H32mm
Weight(one piece)	80g	83g
Packing quantity	150pcs/CTN	100pcs/CTN
Package size	L428×W222×H205mm	L428×W222×H205mm

Description

ZP-LED series thermally protected Surge Protective Device is specially designed to be used in AC power line fixtures for transient overvoltage protection. It is mainly composed of thermally protected varistors and gas discharge tube components. Its built-in thermal disconnect function provides additional protection to prevent catastrophic failure and fire hazard even under the extreme circumstances of varistor end-of-life or sustaining over voltage conditions.

Features

- ◆ Applicable to class I or II luminaire
- ◆ Protection mode: Single phase, Three-phase optional
- ◆ Built in thermal separation function, higher safety
- ◆ Parallel connection mode, with its own lead
- ◆ Excellent surge impact resistance and low residual voltage
- ◆ Miniature size and convenient for embedded installation
- ◆ IP67 Water-proof and Dust-proof.

Applications

- ◆ Street lighting
- ◆ Tunnel lighting
- ◆ Flood lighting
- ◆ Stadium lighting
- ◆ Port lighting
- ◆ Digital signage
- ◆ Gas station lighting
- ◆ AC-LED lighting
- ◆ Traffic lighting
- ◆ Industrial high bay lighting





Repetitive surge capability

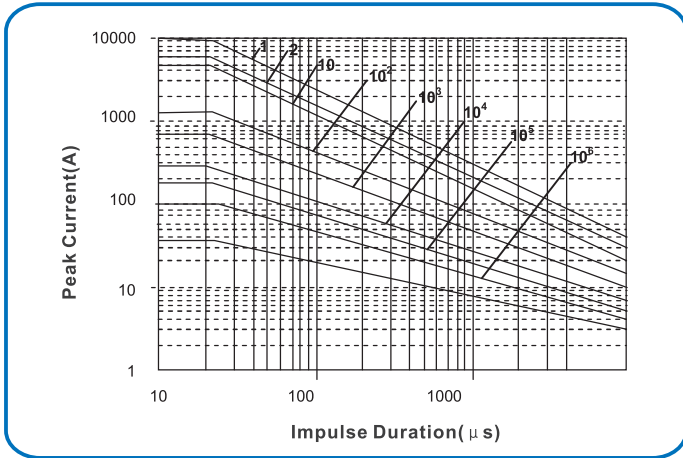

Test waveform

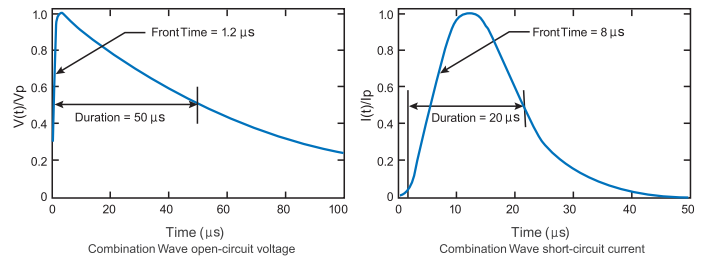

Lightning surge test (8/20 μs)

Surge	Strikes	Lightning surge test (8/20 μs & 1.2/50 μs)	
Surge	Strikes	Surge	Strikes
10000A	1	5kA/10kV	120
7000A	2		
5000A	15		

Notes: IEC 61000-4-5 surge immunity test waveforms: 1.2/50 μs open circuit voltage and 8/20 μs short circuit current.

Dimensions

Unit: (mm)

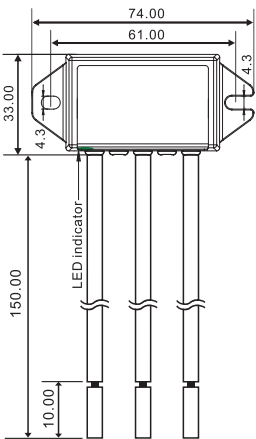

ZP-LED-P10B(3L)

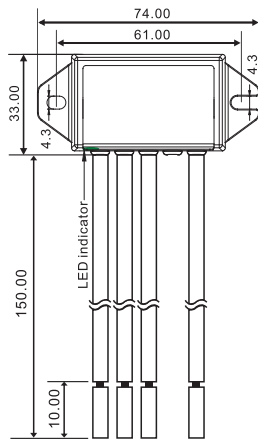

ZP-LED-P10B(5L)

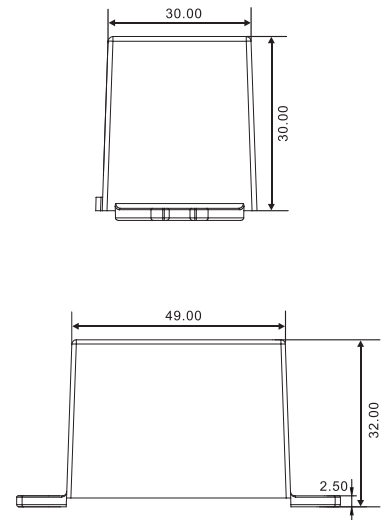
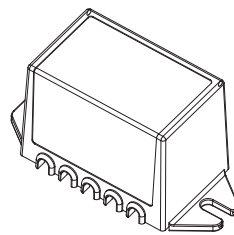

Application / Installation schematic

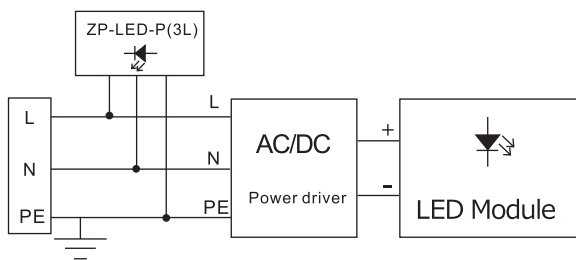

Single-phase connection

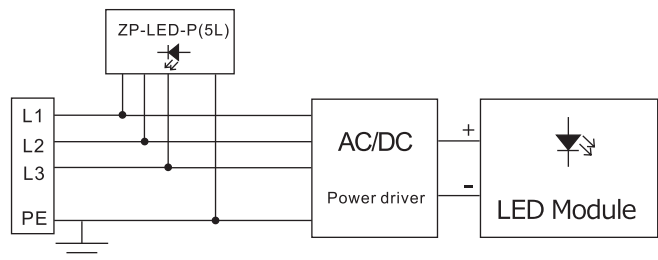

Three-phase connection

Installation instructions:

1. SPD should be installed near the AC side of LED power driver.
2. Single-phase: Brown-phase line (L); Blue-neutral line (N); Yellow&green-ground line (PE).
3. Three-phase: Brown-phase line (L₁); Red-phase line (L₂); Blue-neutral line (L₃); Yellow&green-ground line (PE).
4. Fixed with two M4 screws.

